

Oticon ♦ ConnectLine

INSTALLATION GUIDE ConnectLine TV Adapter Getting started

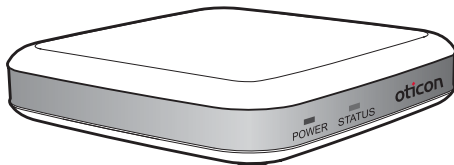

READ THIS FIRST

Before your hearing instruments can receive sound from the TV, the adapter must be connected to the TV and a power outlet.

This is an easy step-by-step guide through the installation of the TV adapter.

All needed parts for the installation are included in the package.

The connection parts are packed in numbered boxes from 1 to 3.
The numbers refer to each step in the installation.

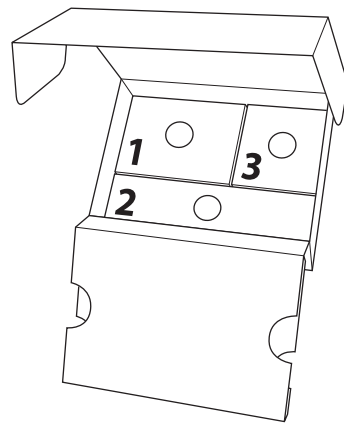

TV ADAPTER OVERVIEW

Back

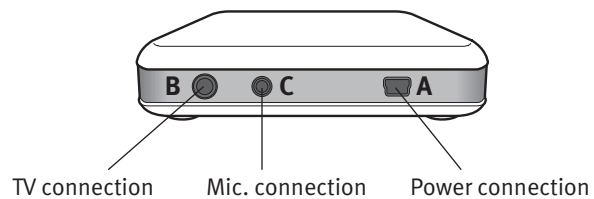

Front

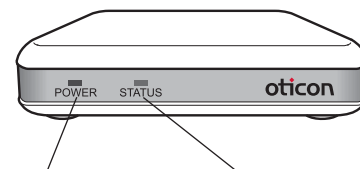

POWER INDICATOR

Light	Meaning
Solid Green	Power on
Off	Power off

STATUS INDICATOR

Light	Meaning
Solid Orange	Connected to Streamer and streaming TV sound
Off	Stand-by
Flashing	Pairing

CONNECTING TO POWER

STEP ONE

Connecting Power Adaptor to TV adaptor.

Use the Power adaptor from box no. **1**.

- Plug the power adaptor into the wall socket or another power source.
- Plug the power cord into the power connection marked **A**.
- Check that power is turned on. A solid green light will appear on the front of the TV adaptor when power is turned on. See illustration page 7

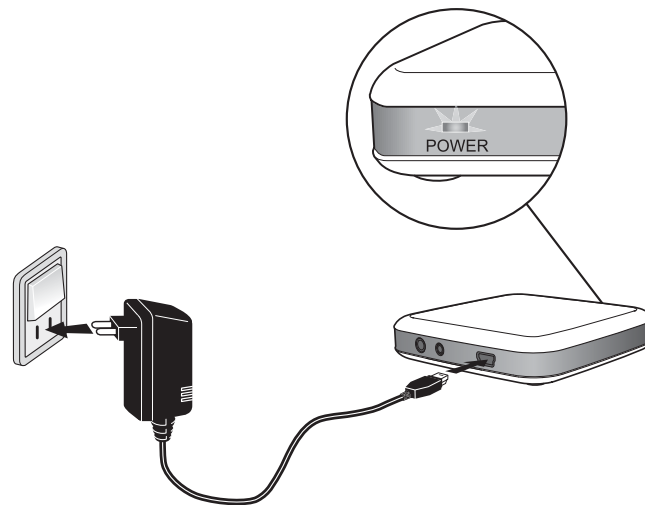
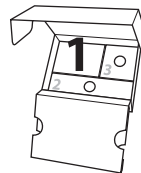

CONNECTING TV CORD TO AUDIO OUTPUT TERMINAL

STEP TWO

Connecting the TV adapter to the TV.

Use the TV cord from box no. **2**.

- Connect the black plug on the TV cord to the port marked **B**.
- Connect the red and white connectors to the “AUDIO OUT” terminals on the TV.
- The audio output jack is usually marked “L – R” “AUDIO OUT” and found on the back of the TV.

*Note: With this installation sound passes through the TV speakers as well as the Bluetooth connection to the hearing aids. See illustration page 9.
Continue to page 16 for PAIRING instructions.*

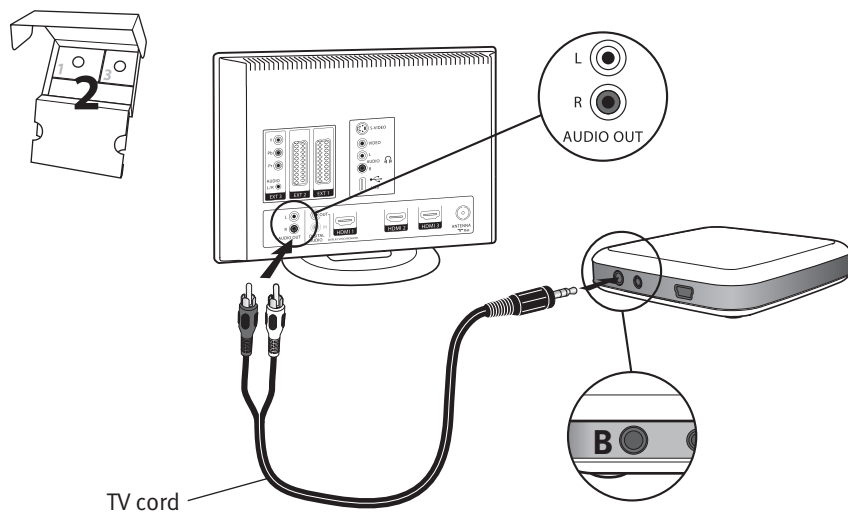



ALTERNATIVE INSTALATION INFORMATION

If the TV does not have an AUDIO OUTPUT terminal, the jack adaptor found in box 3 should be used for connecting the TV cord.

Note: This adaptor plugs into the HEADPHONE jack of the TV in which case only the person wearing the hearing aids will hear the sound.

Proceed to page 12 for installation instructions.

OPTIONAL JACK ADAPTER INSTALATION

If connecting the TV box to the “AUDIO OUTPUT” jack is not possible for your TV, there are two alternative hook ups available. The JACK ADAPTOR and MICROPHONE are found in box 3.

JACK ADAPTOR

- Connect the TV cord to the port marked “B” on the TV adaptor. Plug the JACK ADAPTOR onto the TV cord.
- Plug JACK ADAPTOR into the TV’s “HEADPHONE” output terminal.
- The “HEADPHONE” output terminal is usually located on the side or front of the TV. See illustration page 13.

Note: This adaptor plugs into the headphone jack of the TV in which case only the person wearing the hearing aids will hear the sound. The TV speakers are muted. If this is not desired see alternative installation pages 8 or 14.

OPTION 1: HEADPHONE CONNECTION

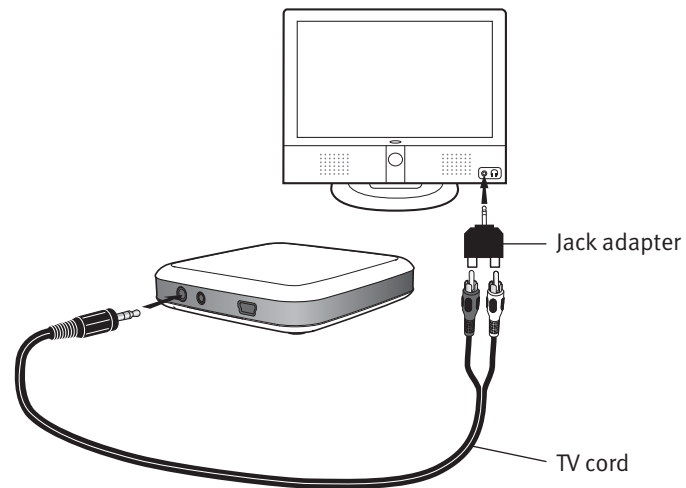
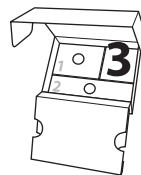

OPTIONAL MICROPHONE INSTALLATION

MICROPHONE INSTALLATION

The TV cord is not used and must be removed from connector marked **B**.

- Connect the microphone cord to the TV adaptor “marked **C**”.
- Place the microphone on the TV speaker. Using the adhesive pad, attach the microphone where the richest sound is found.
- The speaker outlet may also be found on the back or the side of the TV.
See illustration page 15

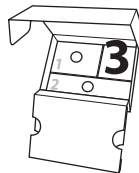

OPTION 2: MICROPHONE INSTALLATION

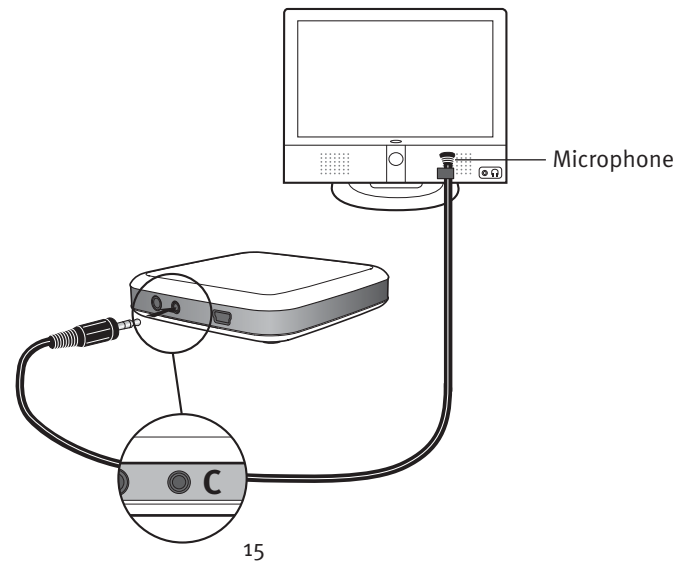

The very first time your Streamer is used with the TV adapter, the two devices must be paired together.

PAIRING:

1. When pairing, the devices must be placed close together. Place the Streamer right next to the TV adapter. (not more than 1 foot away)
2. Press and hold the Streamer “Connect Button” for 5 seconds until the blue light starts flashing rapidly.
3. The two devices establish a connection to each other. Wait one-two minutes.
4. After one-two minutes the TV adapter is connected to Streamer and pairing is complete. The orange STATUS indicator on the TV adapter lights up.

Pairing is done only once and will normally not have to be repeated.

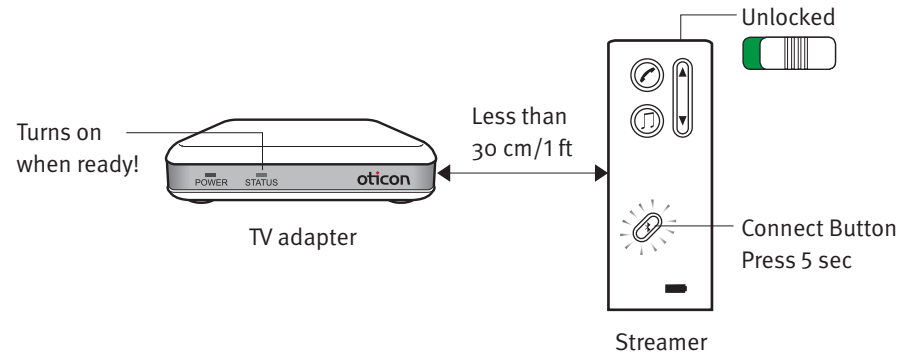

Place the TV adapter in a suitable spot close to the TV. (The adaptor can easily be attached to the top or side of the TV with velcro) For using the Streamer with the TV adapter, refer to the user guide.

Do I have to turn off the TV adapter when I'm not watching the TV?

The TV adapter uses very little power so it is not necessary to turn it off.

What is the TV sound range with Streamer?

TV adapter has a range of about 30 feet depending on furniture and placement.

How often do I have to charge Streamer if I'm watching TV?

The Streamer charge will last up to 5 hours with continuous Streaming. You can however watch TV with the Streamer plugged into its power cord. For further support or tips you can check the ConnectLine information on www.oticon.com/connectline

The TV adapter is covered by a limited warranty issued by the manufacturer for a period of 12 months from the day of the original purchase. Please notice that extended warranties may apply in your country. Please contact your local Hearing Care Professional for more information.

What is covered by this warranty?

Any electrical component, that because of workmanship, manufacturing or design defects fails to function properly under normal use during life of this warranty will be replaced or repaired at no charge for parts or labour when returned to the point of purchase.

If it is determined that repair is not feasible, the entire unit may be replaced with an equivalent unit upon mutual agreement of the Hearing Care Professional and the customer.

What is not covered by this warranty?

Problems arising from improper handling or care, excessive use, accidents, repairs made by an unauthorized party, exposure to corrosive conditions or damage due to foreign objects entering the device are NOT covered by the limited warranty and may void it.

The above warranty does not affect any legal rights that you might have under applicable national legislation governing sale of consumer products. Your Hearing Care Professional may have issued a warranty that goes beyond the clauses of this limited warranty. Please consult your Hearing Care Professional for further information.

PRODUCT APPROVAL PRECAUTIONS AND MARKINGS

The emission power from the TV adapter is below international emission limits for human exposure.

This device complies with Part 15 of the FCC Rules.

Operation is subject to the following two conditions: (1) this device may not cause interference, and (2) this device must accept any interference, including interference that may cause undesired operation of the device.

Changes or modifications not expressly approved by the party responsible for compliance could void the user's authority to operate the equipment.

To comply with FCC RF exposure requirements, the device and the antenna for this device must be installed to ensure a minimum separation distance of 20 cm or more from a person's body. Other operating configurations should be avoided.

NOTE: *This equipment has been tested and found to comply with the limits for a Class B digital device, pursuant to Part 15 of the FCC Rules. These limits are designed to provide reasonable protection against harmful interference in a residential installation. This equipment generates, uses and can radiate radio frequency energy and, if not installed and used in accordance with the instructions, may cause harmful interference to radio communications. However, there is no guarantee that interference will not occur in a particular installation.*

If this equipment does cause interference to radio or television reception, which can be determined by turning the equipment off and on, the user is encouraged to try to correct the interference by one or more of the following measures:

- Reorient or relocate the receiving antenna to the TV.
- Increase the separation between the equipment and receiver.
- Connect the equipment into an outlet on a circuit different from that to which the receiver is connected.
- Consult the dealer or an experienced radio/TV technician for help.

Oticon hereby declares that this TV adapter, TV 75-01 is in compliance with the essential requirements and other relevant provisions of Directive 1999/5/EC.

Declaration of conformity is available at:

Oticon A/S
Kongebakken 9
DK-2765 Smørum
Denmark
www.oticon.com

Use the following switch mode power supply with your TV adapter:
Fuhua, Model No. UE10W-050020SPC, Input: 100-240V AC 150mA 50-60Hz, Output: 5V DC 200mA

CE 0678



Waste from electronic equipment must be handled according to local regulations.



WARNINGS



The TV adapter is not a toy and therefore should be kept out of the reach of children and anyone else who might swallow parts or otherwise cause injury to themselves. Special attention should be paid to the smaller components in order to prevent children from swallowing them and choking.

If a part is swallowed, see a doctor immediately.

The safety of the use of the TV adapter with an auxiliary input cable is determined by external signal source. When the input cable is connected to mains operated equipment, this equipment must comply with IEC-60065, IEC-60601 or equivalent safety standards.

The TV adapter is designed to comply with the most stringent Standards of International Electromagnetic Compatibility. However, the TV adapter might cause interference with other medical devices. Please contact relevant personnel to obtain a permission before using the TV adapter in hospitals or similar venues.

